

Sistem 300

Tek Camlı Cam Cama Bölme Duvar Sistemi

Teknik Döküman

info@ozgunofis.com.tr
www.ozgunofis.com.tr

özgünofis

Sistem 300

System 300

Tek Camlı Cam Cama Bölme Duvar Sistemi

Single Glazed Glass to Glass Partition Wall System

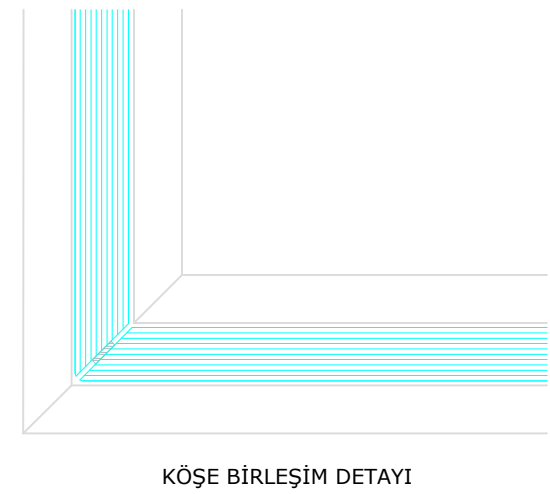
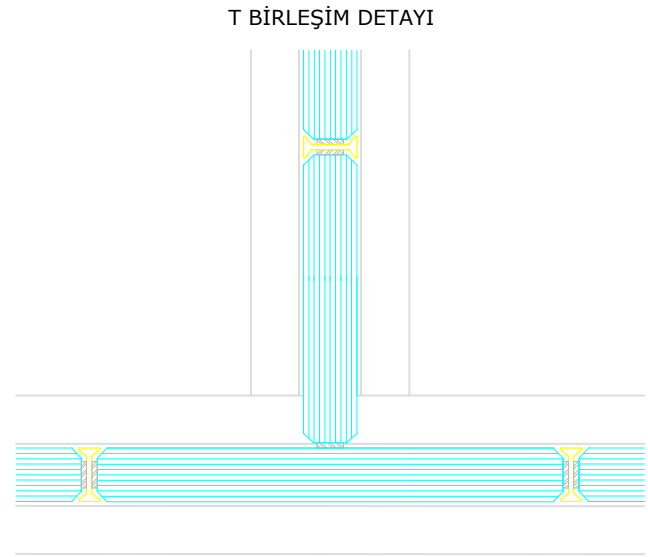
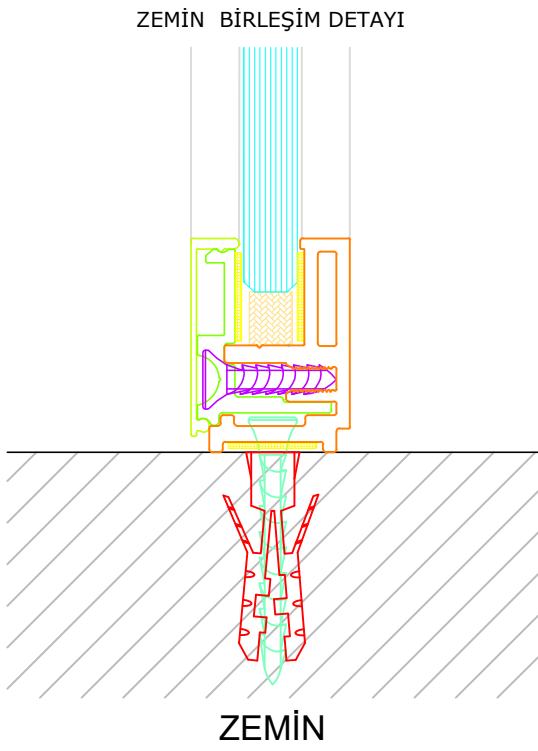
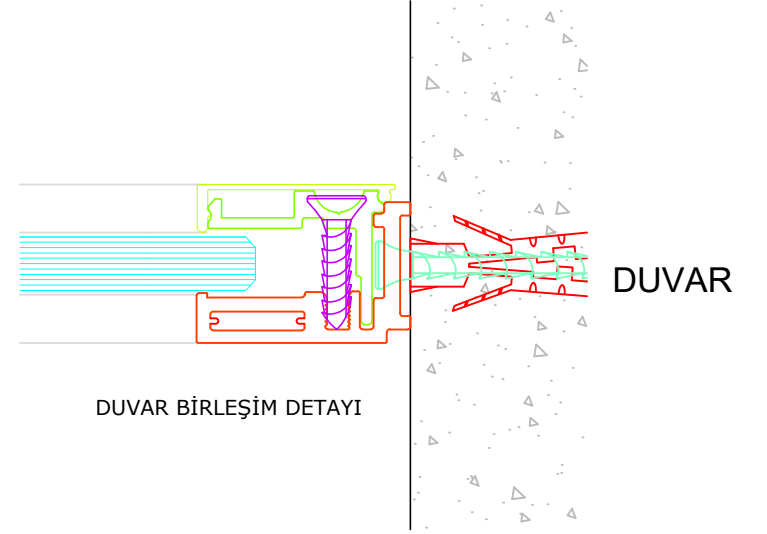
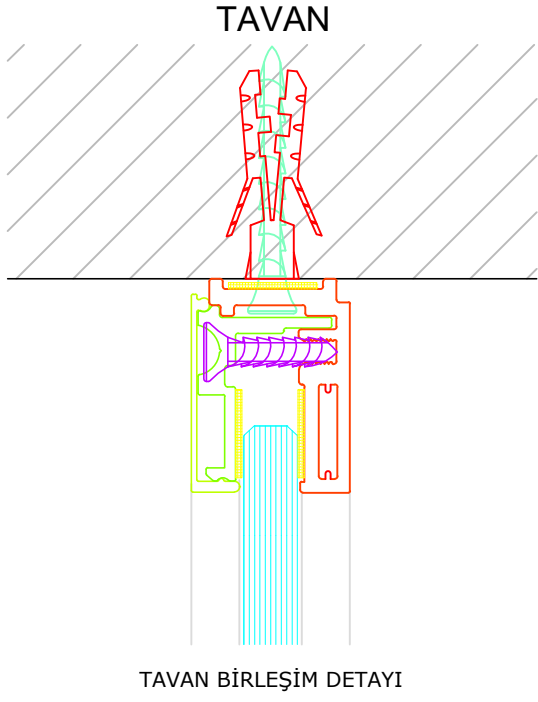

Sistem 300

System 300

Tek Camlı Cam Cama Bölme Duvar Sistemi

Single Glazed Glass to Glass Partition Wall System

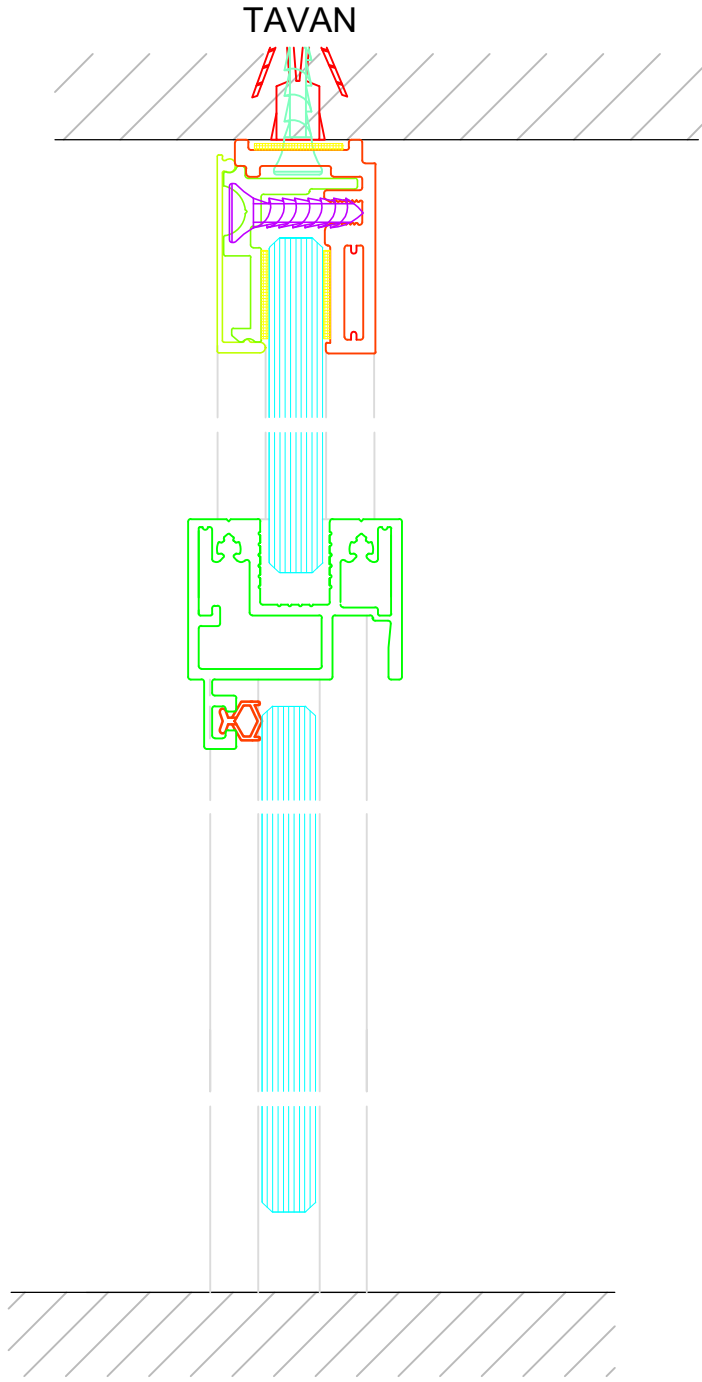

BAŞLIK CAM + CAM KANAT TAVAN BİRLEŞİMİ

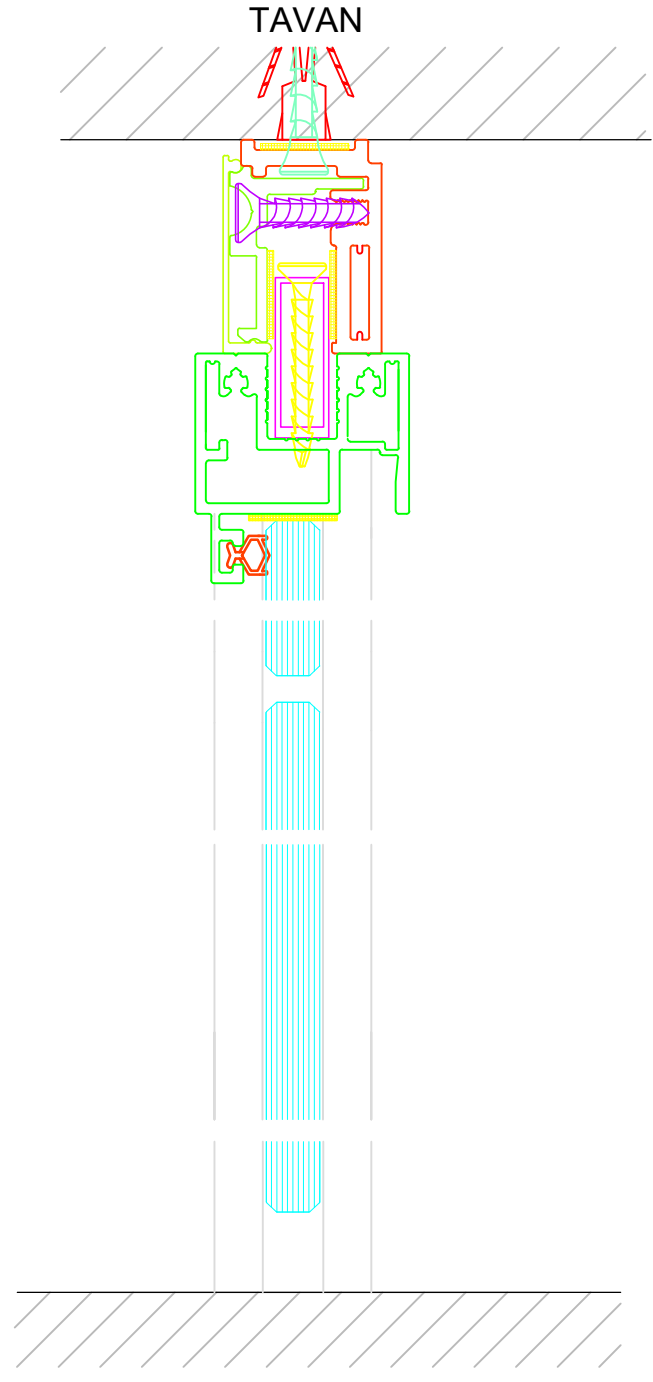

CAM KANAT TAVAN BİRLEŞİMİ

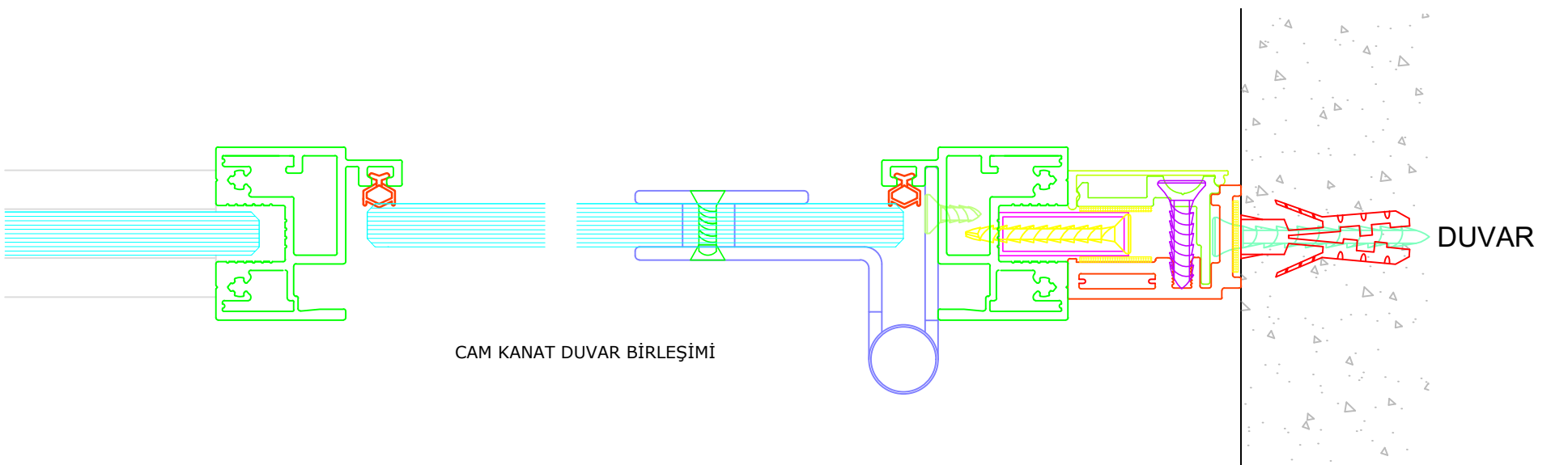

CAM KANAT DUVAR BİRLEŞİMİ

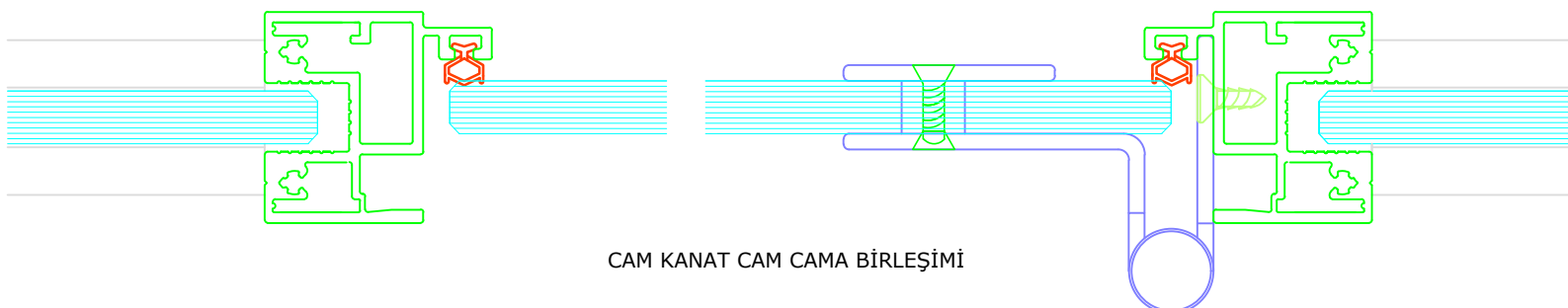

CAM KANAT CAM CAMA BİRLEŞİMİ

Sistem 300

Tek Camlı Cam Cama Bölme Duvar Sistemi

System 300

Single Glazed Glass to Glass Partition Wall System

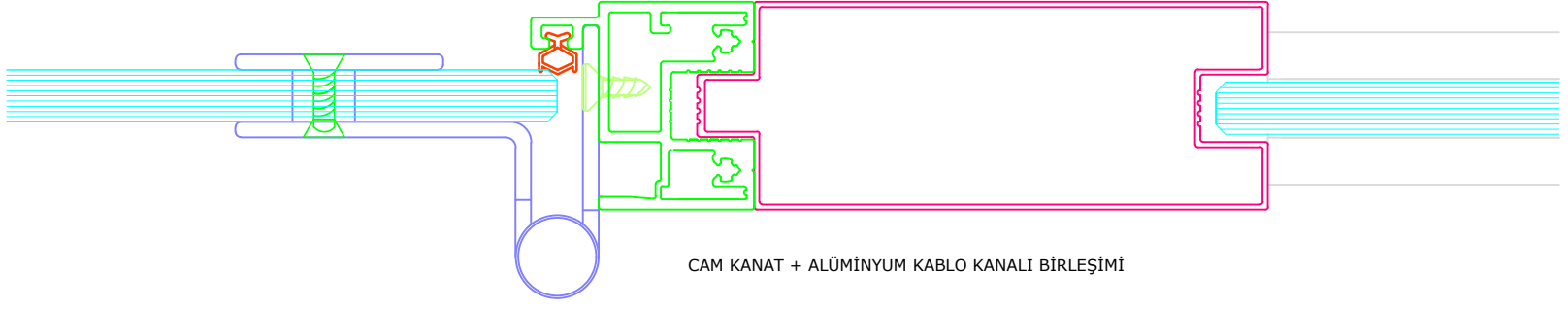

CAM KANAT + ALÜMİNYUM KABLO KANALI BİRLEŞİMİ

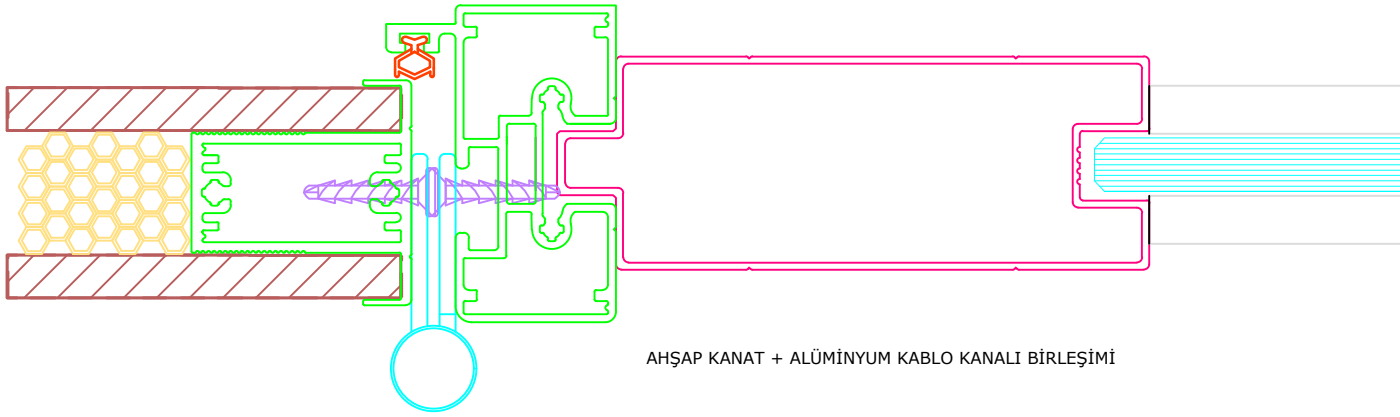

AĞSAP KANAT + ALÜMİNYUM KABLO KANALI BİRLEŞİMİ

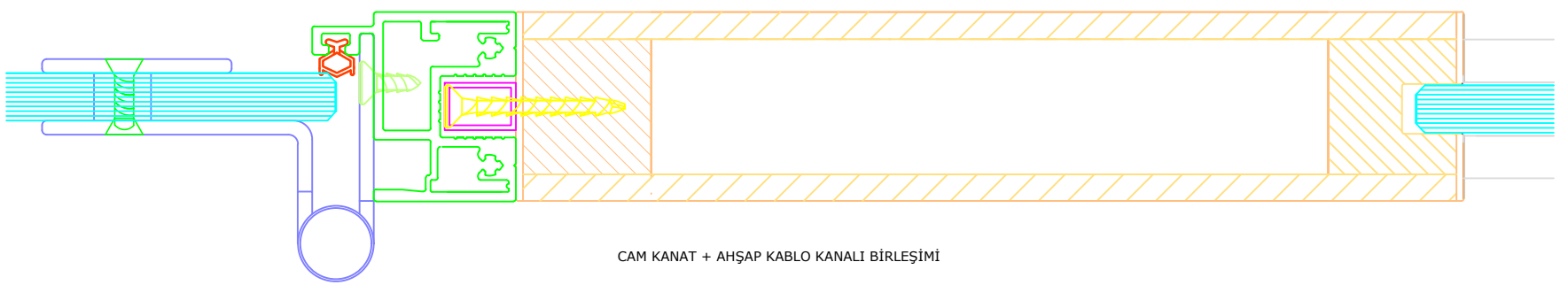

CAM KANAT + AĞSAP KABLO KANALI BİRLEŞİMİ

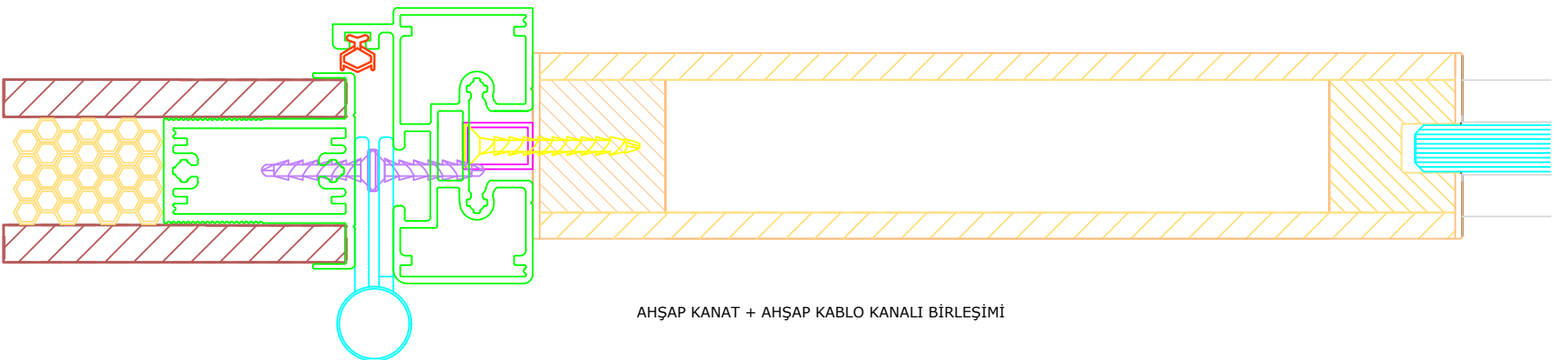

AĞSAP KANAT + AĞSAP KABLO KANALI BİRLEŞİMİ

Sistem 300

System 300

Tek Camlı Cam Cama Bölme Duvar Sistemi

Single Glazed Glass to Glass Partition Wall System

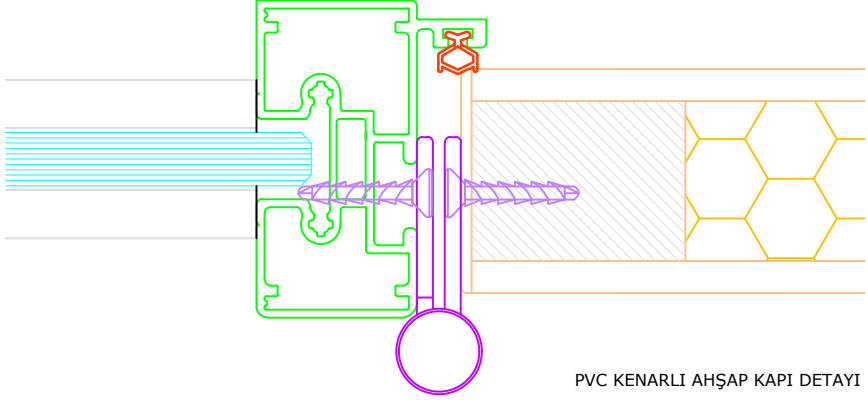

PVC KENARLI AHŞAP KAPI DETAYI

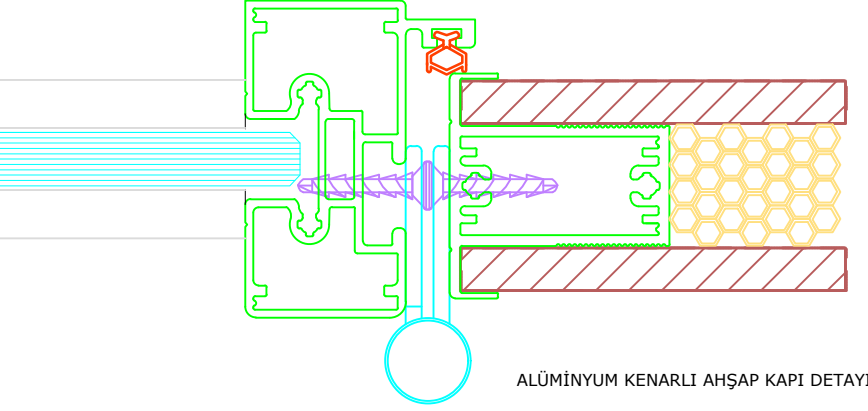
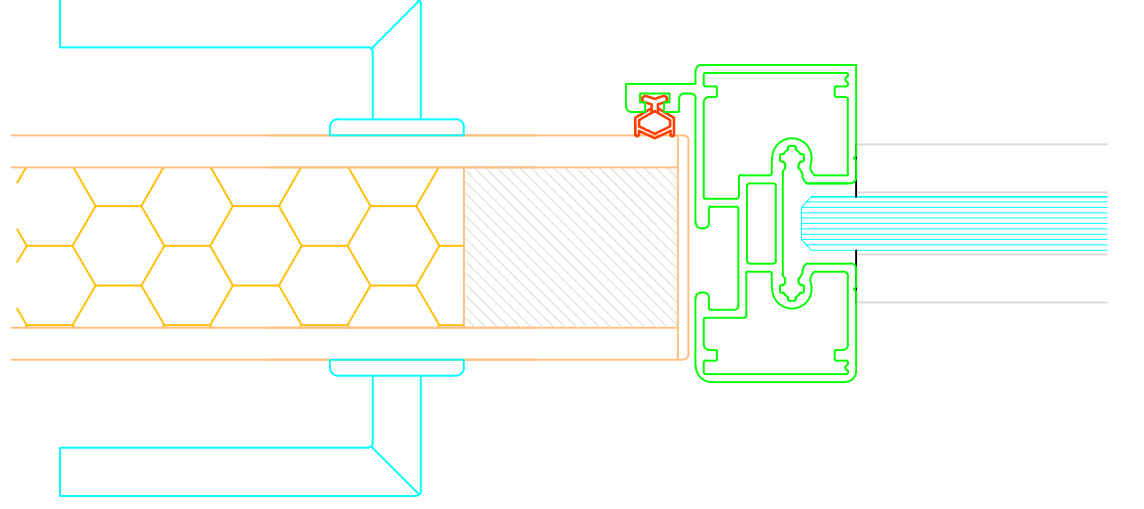

ALÜMİNYUM KENARLI AHŞAP KAPI DETAYI

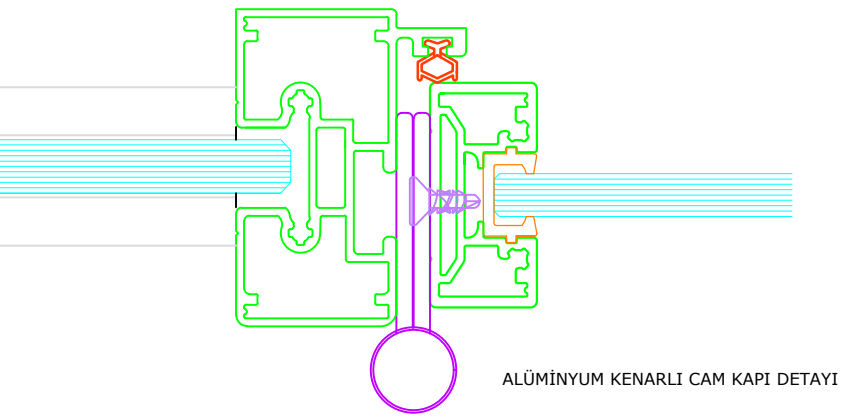
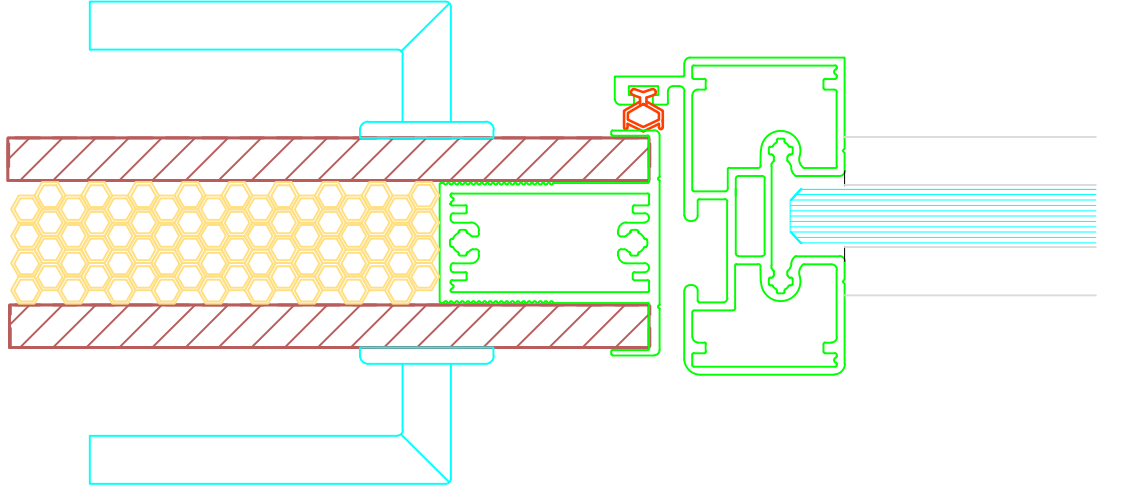

ALÜMİNYUM KENARLI CAM KAPI DETAYI

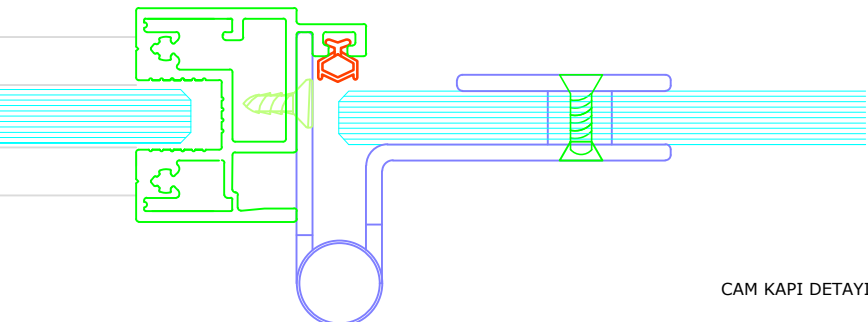
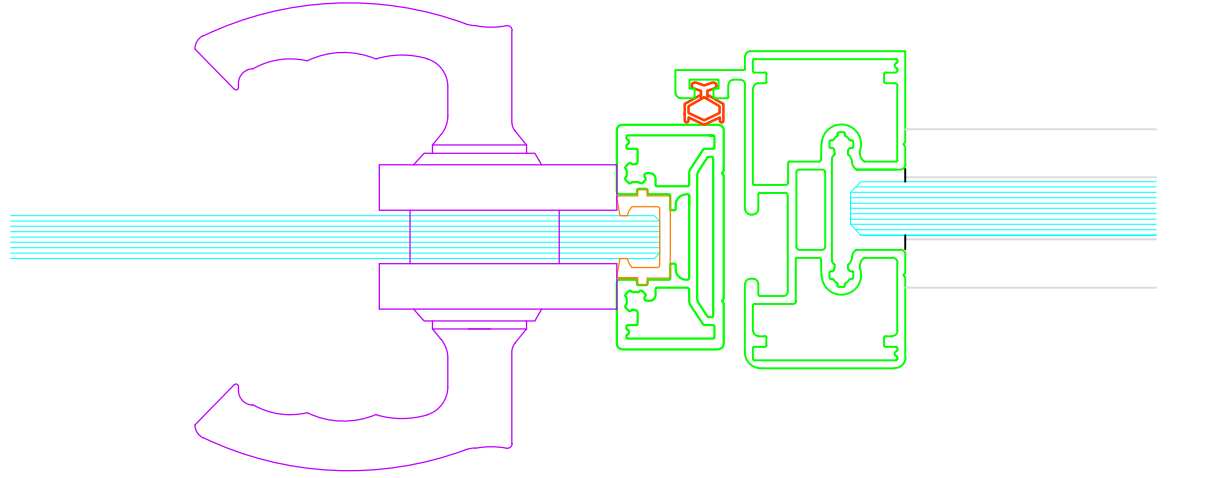

CAM KAPI DETAYI

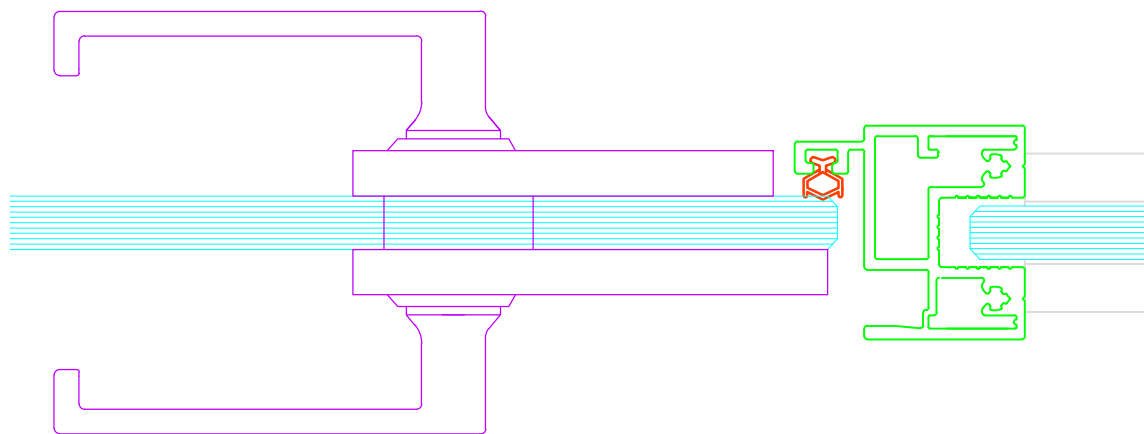

SİSTEM-300 – Cam Cama Modüler Bölme Duvar Sistemi**Combination to the Glass Partition Wall System – SYSTEM 300**

	Standart versiyon	Özel bina proje versiyonu
Ölçüler :	Mimari ihtiyaçlara uygun modüler montaj özellikli	
Duvar kalınlığı :	30 mm	
Genişlikler :	300 / 600 / 1000 / 1200 mm ve ara ölçüler	Max 1200 mm bina içi düşey taşımaya göre
Yükseklikler :	2500 / 2800 / 3000 mm ve ara ölçüler	3000 mm'ye kadar her türlü ara ölçüler
Tolerans :	Yükseklik ve genişlikte 20 mm	
Ağırlık :	25- 35 kg / m ²	
Zemin profili :	40 mm	
Alüminyum profiller :	E6 / EV1 eloksal kaplama veya elektrostatik toz boya	
Profil kalınlıkları :	1.8 - 2 mm alüminyum	
Montaj profilleri :	30 x 40 mm ölçülerinde 3 parçalı alüminyum profil	
Cam montaj profili :	Çift tarafı bantlı şeffaf polikarbon profil	
Camlar :	<ul style="list-style-type: none">✓ 10 mm temperli cam✓ Opak cam✓ 5 + 5 normal lamine ve akustik lamine cam✓ Cam üzeri film kaplama	Mat cam, Lamine cam, Film kaplama
Cam fitilleri :	Montaj profillerinin içerisinde titreşimleri alan akustik bant	
Ses yalıtımı :	Rwp < 47 db	
Köşe dönüşleri :	90 Derece cam cama köşeler	
Kapı kasaları :	Menteşe ve kilit kanallarının kilit karşılığı ile aynı ölçülerde olması nedeniyle, istendiğinde sağ ve sol montaja uygun sistemde kilit karşılığına ihtiyaç bırakmayan formda	Alüminyum kasa Ahşap kaplama kasa
Kapı aksesuarları :	<ul style="list-style-type: none">• Sisteme özel menteşeler• Ofis tipi top kilitler• Cam kapı kilitleri• Barelli tip ahşap kapı kilitleri ve kolları	Müşteri seçeneklerine göre
Kapı kanatları :	<ul style="list-style-type: none">✓ HPL laminat dolu kapı kanadı (Cumba kısımları alüminyum profil)✓ Isıcam arası jaluzili cam kapı kanadı✓ 8 - 10 mm temperli profilsiz cam kapı kanadı✓ Alüminyum çerçeveli 8 mmm temperli cam kapı kanadı	<ul style="list-style-type: none">✓ 40-60 mm kalınlığında Özel Tüm HPL Laminatlar,✓ Doğal ahşap kaplamalar,✓ RAL Cilalı Amerikan kapılar

SİSTEM-300 – Cam Cama Modüler Bölme Duvar Sistemi

Combination to the Glass Partition Wall System – SYSTEM 300

Technical specification

	Standart version	Special building Project version
Dimensions :	<i>In accordance with the architectural requirements</i>	
Wall thickness :	<i>30 mm</i>	
Widths :	<i>Preferred moduls 300 / 600 / 1000 / 1200 mm any kind of inter dimension</i>	<i>Max 1200 mm depending on building facts</i>
Heights :	<i>2500 / 2800 / 3000 mm any kind of inter dimension</i>	<i>All dimensions up to 3000 mm</i>
Tolerance :	<i>Height and width 20 mm</i>	
Weight :	<i>25- 35 kg / m2</i>	
Land profile :	<i>40 mm</i>	
Aluminum profiles :	<i>E6 / EV1 anodic oxidation, Electrostatic powder paint</i>	
Profile thicknesses :	<i>1.8 mm - 2 mm aluminium</i>	
Montage profile :	<i>30 x 40 mm diemensions three parts aluminium profile</i>	
Glass montage profile :	<i>Each face tape transparent polycarbon profile</i>	
Glasses :	<ul style="list-style-type: none"> ✓ 10 mm tempered glass ✓ Opaque glass ✓ 5 + 5 normal lamine glass and acoustic glass ✓ Film Coating 	<i>Mat glass, Laminated glass, Printed</i>
Glass wicks :	<i>Acoustic tape inside of montage profiles</i>	
Sound isolation :	<i>Rwp < 47 db</i>	
Corner posts :	<i>90 Degree glazed to glazed</i>	
Door frames :	<i>Hinge and lock channels in the same measure is a single channel with suitable right and left montage.</i>	<i>Aluminum frames Wood veneered frames</i>
Door accessories :	<ul style="list-style-type: none"> ➤ Hinges special to the system ➤ office type knob lock ➤ Glass door locks ➤ Wooden door locks and handels cylindrical type 	<i>Customer's choice</i>
Door wings :	<ul style="list-style-type: none"> ✓ HPL laminates filled door wings (door thickness aluminim) ✓ 8 - 10 mm tempered glass door wing aluminum frameless ✓ 8 - 10 mm tempered glass door wing with aluminum frame. 	<i>40-60 mm, special all HPL laminates, veneered, RAL painted</i>